

DIGIHEAT IN LINE HEATERS

Installation and operation manual for Single & Three Phase Models

DigiHeat 2.4kW - 10A
DigiHeat 3.6kW - 15A
DigiHeat 4.8kW - 20A
DigiHeat 6.0kW - 25A
DigiHeat 18kW - 25A/Phase
DigiHeat 24kW - 35A/Phase



OFFICES - AUSTRALIA

NSW - Sydney
(HEAD OFFICE)
Tel : +61 2 9898 8686
VIC/ TAS - Melbourne
Tel : +61 3 9764 1211
WA - Perth
Tel : +61 8 9273 1900
QLD - Brisbane
Tel : +61 7 3299 9900
SA/ NT - Adelaide
Tel : +61 8 8244 6000
ACT Distributor
Tel : +61 2 6280 6476

OFFICES - OVERSEAS

Waterco USA
Augusta, USA
Tel : +1 706 793 7291
Waterco Canada
St-Hyacinthe, QC, Canada
Tel : +1 450 796 1421
Waterco (Europe) Limited
Sittingbourne, Kent. UK
Tel : +44(0) 1795 521 733
Waterco (NZ) Limited
Auckland, New Zealand
Tel : +64 9 525 7570

Waterco (C) Limited
Guangzhou, China
Tel : +8620 3222 2180

Waterco (Far East) Sdn. Bhd.
Selangor, Malaysia
Tel : +60 3 6145 6000

PT Waterco Indonesia
Jakarta, Indonesia
Tel : +62 21 4585 1481

Waterco International Pte Ltd
Singapore
Tel : +65 6344 2378

WARNING

This equipment must be installed and serviced by a qualified technician. Improper installation may result in property damage, serious injury or death. Improper installation and/or operation will void the warranty.



Notice to Installer

This manual contains important information about the installation, operation and safe use of this product. Once the product has been installed **this manual must be given to the owner / operator of this equipment.**

WATERCO

Waterco Limited ABN 62 002 070 733

Member
WATER
QUALITY
ASSOCIATION



WATERCO

Water, the Liquid of Life

www.waterco.com

Table of Contents

SAFETY INFORMATION ----- 01

IMPORTANCE OF WATER CHEMISTRY ----- 01

ELECTRICAL & WIRING ----- 02

HYDRAULICS & REQUIRED FLOW RATES ----- 03

ADJUSTING THE PRESSURE SWITCH ----- 03

INSTALLATION ----- 04

THE TOUCHPAD ----- 05

OPERATING THE DigiHeat ----- 06

TEMPERATURE CALIBRATION (bias) ----- 07

LOSS OF POWER ----- 07

EMPTYING THE SPA ----- 07

TROUBLESHOOTING ----- 08

SPECIFICATIONS ----- 09

WARRANTY ----- 09

SAFETY INFORMATION

- The electrical wiring must be permanently hardwired by Qualified Electrician in accordance with all local wiring rules.
- A residual current device (RCD) having a rated residual operating not exceeding 30 mA should be fitted to this appliance.
- The DigiHeat unit has live wiring within the unit and must not be accessible to a person within the spa or pool. Remote temperature controllers with low voltage not exceeding 12 V may be positioned near the spa or pool.
- The DigiHeat must be correctly earthed.
- The installation should be carried out in accordance to local safety standards and bylaws.
- The user should ensure the installation has been carried out by a suitably qualified person and that these instructions have been carefully read and followed. Incorrectly installed equipment may fail, causing severe injury, death or property damage
- This appliance is not intended for use by persons with reduced physical, sensory or mental capabilities, or lack of experience and knowledge; unless they are under supervision or instruction concerning the use of the appliance by a person responsible for their safety.
- To prevent the risk of injury or death do not permit children to use this appliance.
- Do not allow anyone to sit in the spa or pool if the water temperature is greater than 38°C/ 100°F (normal body temperature). Hyperthermia may result.
- In the interests of personal health, it is advised persons should not to stay in the spa for more than twenty (20) minutes at a time.
- In the event of defective operation or fault please ensure that the unit is turned off from the power mains and contact your nearest authorised service agent.
- Ensure ALL valves are open before turning ON power to the pump and the Digiheat.

IMPORTANCE OF WATER CHEMISTRY

The DigiHeat has been carefully designed to withstand the harsh environment of a spa system, and non metallic materials are used extensively. Where metals parts are used however such as heater elements it is important that the water is chemically balanced to ensure that the water is not corrosive or scale forming. Waterco will not be responsible for damage caused by corrosion or scaling.

The chemical balance of water is a relationship between its pH, total alkalinity, calcium hardness and temperature. Your professional pool or spa shop can test the water to ensure it is chemically balanced in accordance with the Langelier Saturation Index.

The water must be maintained at all times as per the following:

- pH level** : between 7.2 & 7.8.
- total alkalinity** : between 80 & 150ppm.
- calcium hardness** : between 150 & 300ppm.

And within these tolerances to be balanced to the Langelier Saturation Index within a range of : -0.2 to +0.2

ELECTRICAL & WIRING

⚠ WARNING

This equipment must be installed and serviced by a qualified technician. Improper installation may result in property damage, serious injury or death. Improper installation and/or operation will void the warranty.

- The electrical wiring must be permanently hardwired by qualified electrician in accordance with all the local wiring rules.
- The appliance shall be supplied through a residual current device (RCD) having a rated residual operating current not exceeding 30mA.
- The DigiHeat must be installed within an area not accessible by any water or persons from within the spa or pool.
- The External Earth Bonding point is available for connection to alleviate cathodolitic corrosion of the element.
- A properly rated isolating switch must be connected from the supply to the DigiHeat with a minimum rated power circuit as specified on the table below.
- Parts incorporating electrical components except remote control device must be located or fixed so that they cannot fall into the spa or pool.
- To access and carry out the electrical connections the front cover with the digital controller needs to be removed. The front cover of the DigiHeat is hinged from the bottom to make it easier to remove and replace it.

To remove the front cover :

- remove the 6 spring loaded quarter turn locking pins first
- pull the cover gently from the top
- now slide the cover across to the left to disconnect the hinges.

Reverse the procedure above to ensure the cover is replaced correctly when all work is completed.

DigiHeat Model	Volts	Current Draw	Minimum Circuit size
2.4 kW	240 Volts (single phase)	10 A	15 A
3.6 kW	240 Volts (single phase)	15 A	10 A
4.8 kW	240 Volts (single phase)	20 A	10 A
6.0 kW	240 Volts (single phase)	25 A	10 A
18.0 kW	415 Volts (single phase)	25 A/phase	30 A/phase
24.0 kW	415 Volts (single phase)	35 A/phase	30 A/phase

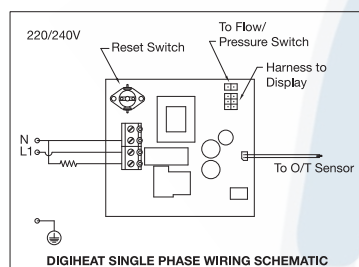

DigiHeat Single Phase

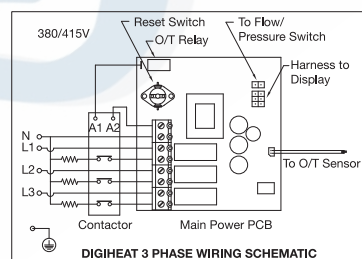

DigiHeat 3 Phase

HYDRAULICS & REQUIRED FLOW RATES

⚠ WARNING

This equipment must be installed and serviced by a qualified technician. Improper installation may result in property damage, serious injury or death. Improper installation and/or operation will void the warranty.

- Water must flow from left to right (when facing the DigiHeat). There are arrows marked on the housing to assist in determining the correct direction.
- The DigiHeat should be positioned upstream from any chemical dosing or chlorinator and a check valve should be installed to prevent corrosive water from flowing back into the DigiHeat.
- In the event of DigiHeat being installed more than 1.8m below the pool water level the adjustable pressure switch will not work. A flow switch must be installed in place of the pressure switch.
- Required flow rates table

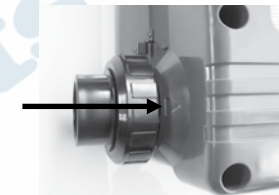

DigiHeat Model	Minimum Flow Rate (litres per minute)	Maximum Flow Rate (litres per minute)
2.4 kW	100	350
3.6 kW	100	350
4.8 kW	100	350
6.0 kW	100	350
18.0 kW	150	450
24.0 kW	150	450

HYDRAULICS & REQUIRED FLOW RATES

⚠ WARNING

This equipment must be installed and serviced by a qualified technician. Improper installation may result in property damage, serious injury or death. Improper installation and/or operation will void the warranty.

To adjust the pressure switch:

- Switch OFF the power to the DigiHeat.
- Remove front cover of DigiHeat.
- Ensure the filter is clean & run the pump with the filtration system as normal (FILTER MODE) until all the air has been bled from the system.
- Turn the pump OFF and check that the pressure switch turns OFF immediately or after a short delay (1 to 2 secs). If it is not possible to hear the pressure switch operate, connect an Ohmmeter across the Pressure Switch terminals.
- If the pressure switch remains ON after the pump stops, increase the operating pressure by turning the small adjusting screw slowly clockwise until the switch turns OFF.

- If the adjustment required is outside the range of this switch then a different switch or a flow switch will be needed to protect the heater.
- Stop and start the pump several times to check the correct operation. Repeat if necessary.
- Replace front cover on DigiHeat.

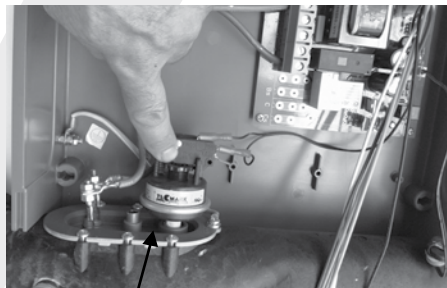

pressure switch adjustment screw

INSTALLATION

DigiHeat single phase models can be mounted directly onto the pipework, fixed to a wall or base mounted. Wall and base fittings are supplied.

Digiheat three phase units can be mounted directly onto the pipework or fixed to a wall. Wall fittings are supplied with the unit.

Direct mounting onto pipework

- simply connect the Digiheat to the pipework. Ensure the pipework is rigid and secure.



small mounting brackets

wall mounting

- use the 4 small mounting brackets supplied. Slide two small mounting brackets into the channel located on the top of the Digiheat and the same on the bottom.



base mounting

- use the 2 large mounting brackets supplied (single phase model only). Slide two large mounting brackets into the channel located on the bottom of the DigiHeat

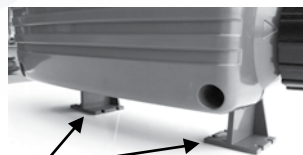

large mounting brackets

THE TOUCH PAD

- | | |
|-------------------------------|--|
| 1. Digital display. | Displays the water temperature, bias setting and fault codes. |
| 2. On/Off button. | Used to switch the Digiheat On or Off. |
| 3. Up arrow button. | Used to increase the desired water temperature and also increase the bias setting. (refer to bias adjustment section.) |
| 4. Down arrow button. | Used to decrease the desired water temperature and also decrease the bias setting. (refer to bias adjustment section.) |
| 5. °C/°F button. | Use to toggle between Farenheit and Celcius. |
| 6. °C indicator light. | temperature displayed in °C |
| 7. °F indicator light. | temperature displayed in °F |

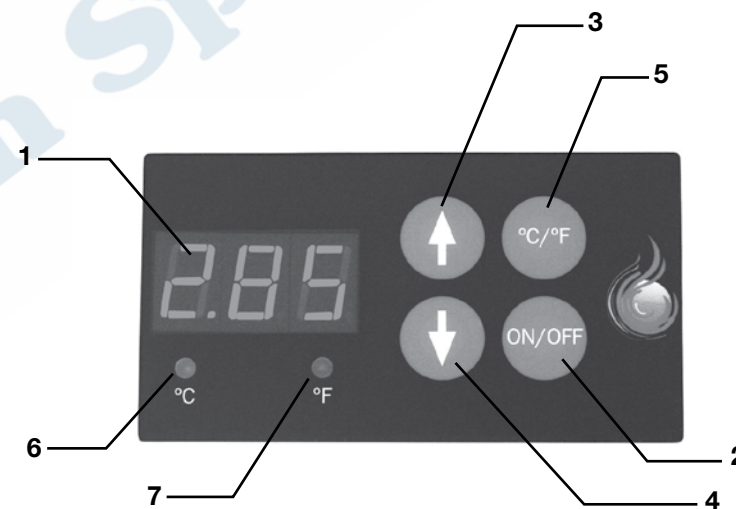

Digiheat Touch-Pad

OPERATING THE DIGIHEAT

After familiarising yourself with the layout and settings of the touch pad (see previous section), fill the spa or pool with water and follow the instructions below.

We suggest that you instruct all the people who will use the spa or pool fitted with the DigiHeat on how to operate it by either by giving them this manual or by showing them yourself.

Reading, understanding and following this guide should lead to trouble free operation of the DigiHeat spa and pool heater.

1. Fill the spa or pool with water and then switch on the water pump.
2. Switch on the power to the DigiHeat. The controller will then display "OFF" or the water temperature. If the pump is not running or if there is insufficient water flow, "nFL" will be displayed. (Please refer to troubleshooting section of this manual for "nFL")
3. If the display reads "OFF" press the on/off button to switch on the Digiheat, the temperature will then be displayed.
4. Press and release the Up or Down button and the set temperature will be displayed with either the °C or °F indicator LED flashing.
 - To increase the desired set temperature press and hold the up button which will allow the set temperature to be raised up to a maximum of 40°C (104°F). Release the button when the desired temperature is displayed on the screen.
 - To decrease the desired water temperature press and hold the down button. Release the button when the desired temperature is displayed on the screen.
5. With an accurate thermometer check that the actual water temperature in the pool or spa is the same as the temperature displayed on the Digiheat.

If the displayed water temperature is different to the actual water temperature the controller will need to be calibrated. This can only be done whilst the temperature is shown in °C. Refer to the following section "temperature calibration".

TEMPERATURE CALIBRATION (bias)

It is possible to have a temperature variation between the water in the spa or pool and the DigiHeat controller. This is also referred to as the "Bias" adjustment setting. This adjustment can only be carried out whilst the controller is set for "C" (centigrade).

Example: if the water in the pool or spa is 26° C and the DigiHeat control displays 24°C.

To calibrate the temperature variation, set the bias to +2 with the following procedure:

1. Switch on both the pump and the Digiheat.
2. With the use of an accurate thermometer read the pool or spa water temperature (e.g.: 26°C).
3. Next read the temperature displayed on the DigiHeat control (eg: 24°C).
4. To determine the bias setting subtract the pool or spa water temperature from the DigiHeat Temperature.

Eg : 26 - 24 = 2°C. Therefore we must compensate for the variation by setting the bias to +2.
If the temperatures were reversed eg; the water temperature was 24 and the Digiheat control was 26 we would require a bias setting of -2.

Eg : 24 - 26 = -2. Therefore we must compensate for the variation by setting the bias to -2.
5. Enter the programming mode by simultaneously pressing on the UP and DOWN arrows.
6. Once the temperature display is flashing press on the ON/OFF button.
7. Using the UP and DOWN arrows, enter the calibration value, (+2). In this case, by pressing the UP arrow twice.(if the down arrow is used the bias will be a negative figure)
8. Once the bias has been entered wait until the calibrated temperature appears back on the display.

LOSS OF POWER

If the power supply to the Digiheat is lost, either by disconnecting it from the power supply or from a "blackout", when power is restored the DigiHeat will operate as follows,

1. If the Digiheat was "ON" prior to the power interruption, it will continue heating if the pump is running and the set temperature is higher than the displayed temperature when the power is restored. If the pump is not running the display will show nFL.
2. If the Digiheat was switched "OFF" prior to the power interruption, it will remain "OFF" when power is restored.

EMPTYING THE SPA

If you intend emptying the water from the spa, disconnect the Digiheat and pump from the power supply (isolating switch) to ensure the Digiheat will not be accidentally switched on while the spa is empty. The pump can be damaged if it is run without water. Serious damage or injury may result.

TROUBLESHOOTING

The spa pump should only be serviced by qualified service technicians. However, some problems can be checked and rectified by the owner before making a service call.

FAULT	POSSIBLE CAUSE	ACTION
Display is blank nFL o/t	No power	Check the isolating switch is on and not damaged.
	Blown fuse	Check the power circuit fuse or circuit breaker has not blown or tripped.
	RCD tripped	Reset RCD.
	Pump not on or pressure switch needs to be adjusted	Switch on pump or adjust pressure switch.
	Over-Temperature Reset Switch tripped	See "Over-Temperature Reset Switch tripped" below.
	Water inside Digiheat reached 45°C /113°F (spa water is still cold)	Check for and remove blockages in the filter and pipe-work. Check for blockages in the impeller and call for service if items are found in the pump/impeller. Press Over-Temperature RESET.
Over-Temperature Reset Switch tripped (touch pad power indicator light blinking)	Water in spa reached 45°C /113°F (touch pad shows lower temperature)	Properly secure sensor in housing (refer to "Installing the Sensor" on page Press Over-Temperature RESET.
	Over-Temperature Sensor not connected or faulty	Re check Temperature Bias (refer to "temperature calibration") Press Over-Temperature RESET. Call service to connect or replace.
Over-Temperature Reset Switch tripped shortly after power-up	Over temperature Sensor not connected.	Check sensor is connected to Control Box. If not, call service to connect the sensor.
Touch pad display shows 00	Temperature Sensor faulty.	Call for service to replace Temperature Sensor.
	Water level too low	Add water to spa or pool to operate pressure switch.
Heater will not operate	Faulty element	Call for service.

Specifications

Model	Weight (kg)	Min Flow Rate (lpm)	Max Flow Rate (lpm)	Supply Voltage (volts)	frequency (Hz)	amps	minimum circuit size (amps)	IP rating	Max Pressure (kpa) @ 31m head
2.4 kW	3.5	100	350	240	50	10	15	IP23	300
3.6 kW	3.5	100	350	240	50	15	20	IP23	300
4.8 kW	3.5	100	350	240	50	20	25	IP23	300
6.0 kW	3.5	100	350	240	50	25	30	IP23	300
18.0 kW	9.5	150	450	415	50	25 /phase	30	IP23	300
24.0 kW	9.5	150	450	415	50	35 /phase	40	IP23	300

Complies with EN60335.2.60 and AS3136/NZS6232.

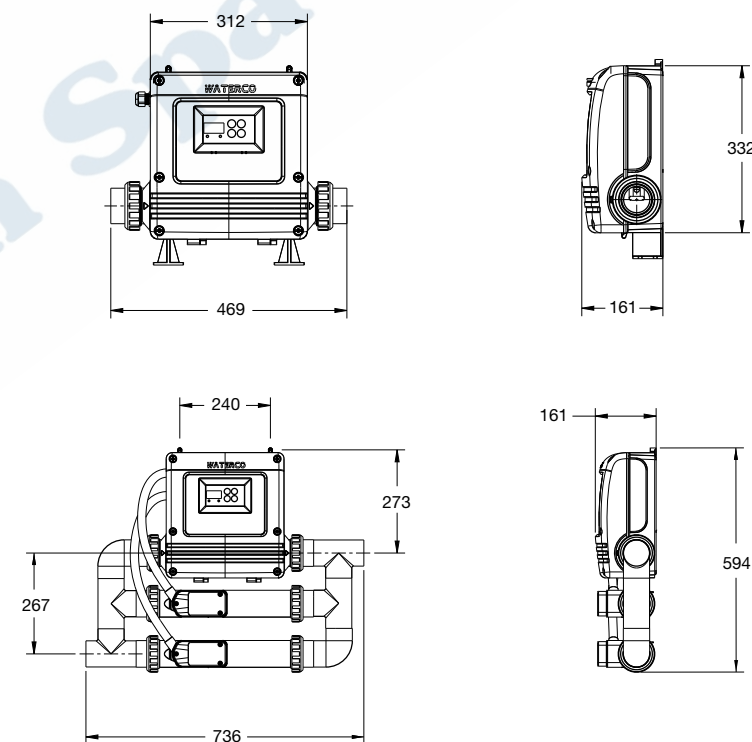

WARRANTY

Waterco DigiHeats are covered by a comprehensive 12 month warranty. Please refer to Waterco's warranty terms and conditions.